



## MULTI CROSS FORTE

Highly Flexible Coupling with Progressive Torsional Deflection Characteristic

[www.reich-kupplungen.com](http://www.reich-kupplungen.com)



SIMPLY **POWERFUL.**





## D2C – Designed to Customer

The guiding principle of Designed to Customer is the recipe for success behind REICH. In addition to the catalogue products, we supply our customers with couplings developed to their specific requirements. The designs are mainly based on modular components to provide effective and efficient customer solutions. The special nature of our close cooperation with our partners ranges from; consulting, development, design, manufacture and integration to existing environments, to customer-specific production, logistics concepts and after-sales service - worldwide.

This customer-oriented concept applies to both standard products and production in small batch sizes.

The company policy at REICH embraces, first and foremost, principles such as customer satisfaction, flexibility, quality, prompt delivery and adaptability to the requirements of our customers.

REICH provides you with not only a coupling, but a solution:

Designed to Customer – SIMPLY **POWERFUL**.

**D2C**  
Designed to Customer



# MULTI CROSS FORTE

## Contents

### Coupling Information

**04** General Technical Description

---

**05** Advantages

---

**06** General Technical Data

---

**07** Materials

---

**08** Selection of the Coupling Size

---

**09** Service Factors

---

**11** Mounting for Rubber Elements

### Dimension Tables

**10** Type MCF...W and MCF...F

# MULTI CROSS FORTE

## General Technical Description

### MULTI CROSS FORTE

## Highly Flexible Coupling with Progressive Torsional Deflection Characteristic

The MULTI CROSS FORTE (short form: MCF) is a highly flexible coupling with progressive torsional stiffness. The special characteristic of all MULTI CROSS FORTE couplings is the use of individual transmission elements, which are alike within the same type series, but vary in number depending on the coupling size.

This means that only three sizes of coupling elements are required to cover the entire MULTI CROSS FORTE coupling program with a torque range from 160 Nm to 54 000 Nm. The result is a really simple and therefore cost-effective spare parts inventory. Because of the use of the form-fit bolted elements they can be easily be assembled or disassembled – even with the biggest MULTI CROSS FORTE couplings.

The element bolting principle offers universal combinability, allowing the connection of parts directly to other mechanical parts that have the same connection dimensions.



## MULTI CROSS FORTE

Nominal torques from 160 Nm to 54 000 Nm

## MULTI CROSS FORTE

### Advantages

**Salient features and advantages of the MULTI CROSS FORTE coupling:**

- Very high torsional flexibility with a progressive torsional characteristic line
- High compensation capability of axial, radial and angular displacement
- Backlash-free torque transmission even in case of alternating directions of rotation
- High torsional vibration and shock load absorbing capability
- Good heat dissipation which may be generated by the damping effect of the coupling
- Easy alignment of the coupling
- Positive fit between transmission element and hub flange to prevent relative movement
- Cost-effective spare parts inventory by use of the same element size within one series type

# MULTI CROSS FORTE

## General Technical Data



### Standard Type

Coupling size	Nominal torque	Maximum torque	Continuous fatigue torque	Dynamic torsional stiffness $C_{T\text{ dyn}}$				Stat. Torsional angle $\varphi$ at	Rel. damping	Max. speed	Axial misalignment	Radial misalignment	
	$T_{KN}$	$T_{K\text{ max}}$	$T_{KW}$ (10 Hz)	$0,25 T_{KN}$	$0,50 T_{KN}$	$0,75 T_{KN}$	$1,00 T_{KN}$	$T_{KN}$	$\psi$	$n_{\text{max}}$			
	[Nm]	[Nm]	[Nm]	[Nm/rad]	[Nm/rad]	[Nm/rad]	[Nm/rad]	-	-	[min <sup>-1</sup> ]			
Type series 5	MCF 53	160	480	53	290	500	650	1100	40°	1.2	4500	±4	3
	MCF 54	250	750	83	380	670	875	1500	40°	1.2	4500		
	MCF 55	500	1500	165	720	1270	1650	2800	30°	1.2	3800		
	MCF 56	630	1890	210	900	1600	2100	3600	28°	1.2	3700		
	MCF 58	1100	3300	365	1650	2900	3750	6400	22°	1.2	3000		
	MCF 510	1600	4800	500	2360	4160	5410	9300	20°	1.2	2800		
Type series 6	MCF 65	2500	7500	900	6600	9000	11500	13700	35°	1.2	2300	±8	5
	MCF 66	4000	12000	1400	11000	14500	18400	22000	27°	1.2	1900		
	MCF 68	6300	18900	2200	17000	23400	29700	35500	22°	1.2	1700		
	MCF 69	7600	22800	2600	20100	27600	35000	42000	21°	1.2	1600		
	MCF 610	10000	30000	3400	26800	36700	46600	55700	18°	1.2	1500		
Type series 7	MCF 75	14000	42000	4700	35000	58000	75700	119000	24°	1.2	1350	±12	10
	MCF 76	20000	60000	7000	50000	83000	108000	170000	21°	1.2	1200		
	MCF 78	35000	105000	12000	86700	144000	187000	294000	16°	1.2	1000		
	MCF 710	54000	162000	18000	134000	223000	290000	457000	13°	1.2	900		

### Technical Note

The technical data applies only to the complete coupling or the corresponding coupling elements. It is the customer's/user's responsibility to ensure there are no inadmissible loads acting on any of the components. In particular, existing connections, e.g. bolted connections, must be checked with regard to the torques to be transmitted. If necessary, further measures, such as additional reinforcement with pins, may be necessary. It is the customer's/user's responsibility to make sure the dimensioning of the shaft and keyed or other connection, e.g. shrinking or clamping connection,

is correct. All components that can rust are protected against corrosion as standard.

REICH have an extensive range of couplings and coupling systems to cover nearly every drive configuration. Customized solutions can be developed and manufactured even in small batches or as prototypes. In addition calculation programs are available for all necessary dimensioning.

# MULTI CROSS FORTE

## Materials



### Overview of materials in standard versions

Part No.	Designation	Materials
1	Coupling hubs	Sizes 53 - 66: Grey cast iron GG25 Sizes 68 - 710: Steel (yield strength min. 360 MPa)
2	Rubber elements	Natural/synthetic caoutchouc NR-SBR 60-65 °Shore A with cord reinforcements Permitted application temperature up to 80 °C

### Examples of other types

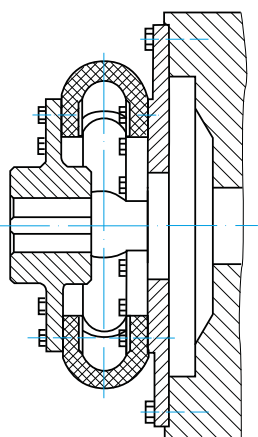

Flange coupling MCF...F2

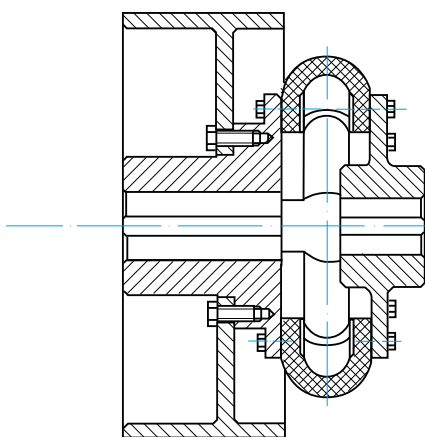

Brake drum coupling MCF...BT

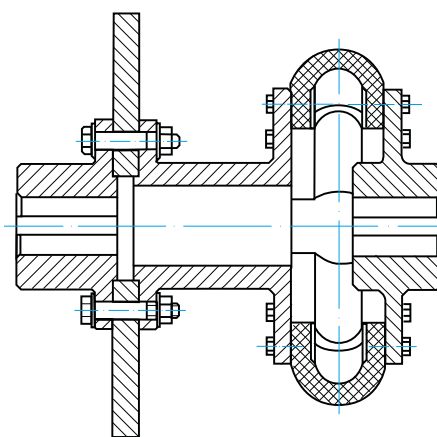

Brake disc coupling MCF...BS

# MULTI CROSS FORTE

## Selection of the Coupling Size

The coupling size should be selected to ensure that the permissible coupling load is not exceeded in any operating condition encountered. For drives which are not subject to periodically recurring fatigue torques the coupling design may be selected based on the driving torque with reference to the corresponding service factors. Otherwise the selection shall be verified by means of a full torsional vibration analysis, which will be conducted by us on request.

**In selecting the coupling size the following should be satisfied:**

-  The **nominal torque of the coupling**  $T_{KN}$  must be taken into account at every temperature and operating load of the coupling, whilst observing the service factors  $S$  (e.g. temperature factor  $S_t$ ) shall be at least equal to the maximum nominal torque on the drive side  $T_{AN}$ ; the temperature in the immediate vicinity of the coupling must be taken into account.

$$T_{KN} \geq T_{AN} \cdot S_m \cdot S_t \cdot S_z$$

-  The **nominal torque on the drive side**  $T_{AN}$  is calculated with the driving power  $P_{AN}$  and the coupling speed  $n_{AN}$ .

$$T_{AN} [\text{Nm}] = 9550 \frac{P_{AN} [\text{kW}]}{n_{AN} [\text{min}^{-1}]}$$

-  The **maximum torque capacity of the coupling**,  $T_{K \max}$  must be at least equal to the highest torque  $T_{\max}$  encountered in operation while taking the temperature factor  $S_t$  and the start-up factor  $S_z$  into account.

$$T_{K \max} \geq T_{\max} \cdot S_z \cdot S_t$$

-  A continuous torsional vibration analysis to verify the coupling selection should confirm that the permissible **continuous fatigue torque**  $T_{KW}$  is at least equal to the highest fatigue torque  $T_W$  under reversing stresses encountered throughout the operating speed range while taking into account the temperature and frequency.

$$T_{KW} (10 \text{ Hz}) \geq T_W \cdot S_t \cdot S_f$$

-  The **frequency factor**  $S_f$  allows for the frequency dependence of the permissible continuous fatigue torque under reversing stresses  $T_{KW} (10 \text{ Hz})$  with an operating frequency  $f_x$ .

$$S_f = \sqrt{\frac{f_x}{10}}$$



# MULTI CROSS FORTE

## Service Factors

### Load classification $S_m$

Prime mover	Load classification of the driven machine			
	G (uniform load)	M (medium load)	S (heavy load)	E (Extreme load)
Electric motors, turbines, hydraulic motors	1.25	1.6	2.0	2.8
Combustion engines $\geq$ 4 cylinder Degree of uniformity $\geq$ 1:100	1.5	2.0	2.5	3.5

### Temperature factor $S_t$

Ambient temperature	-40 °C +30 °C	+40 °C	+60 °C	+80 °C	> +80 °C
$S_t$	1.0	1.1	1.4	1.8	on request

### Start-up factor $S_z$

Starting frequency per hour	30	60	120	240	> 240
$S_z$	1.0	1.1	1.2	1.3	on request

# MULTI CROSS FORTE

Type MCF...W and MCF...F

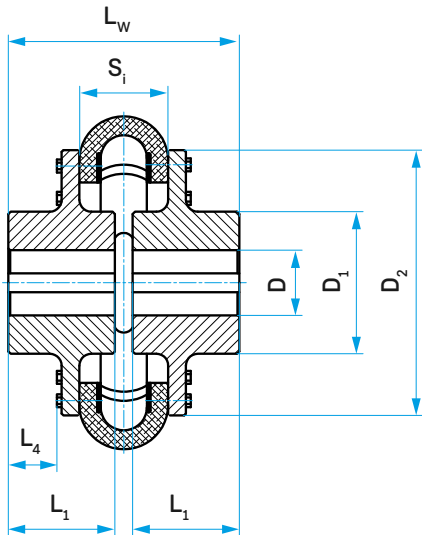

MULTI CROSS FORTE shaft coupling MCF...W

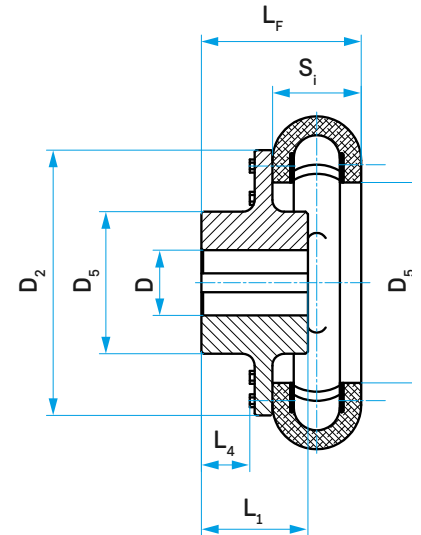
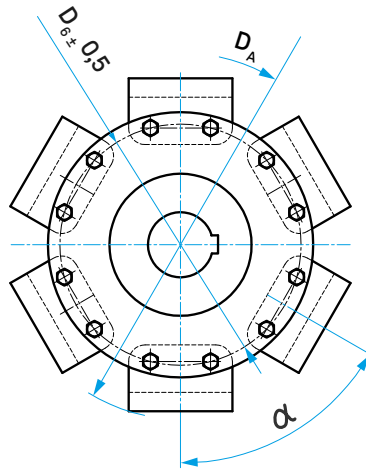

MULTI CROSS FORTE-flange coupling MCF...F

## Coupling details

Coupling size	D <sub>A</sub> [mm]	D		D <sub>1</sub> [mm]	D <sub>2</sub> [mm]	D <sub>5</sub> [mm]	D <sub>6</sub> [mm]	α°	L <sub>1</sub> [mm]	L <sub>4</sub> [mm]	L <sub>W</sub> [mm]	L <sub>F</sub> [mm]	S <sub>i</sub> [mm]	MCF...W		MCF...F	
		min. [mm]	max. [mm]											m <sub>ges</sub> <sup>1)</sup> [kg]	J <sub>ges</sub> <sup>1)</sup> [kgm <sup>2</sup> ]	m <sub>ges</sub> <sup>1)</sup> [kg]	J <sub>ges</sub> <sup>1)</sup> [kgm <sup>2</sup> ]
MCF 53	190	unbored, precentered	50	80	120	62	100	120	50	21	155	115	75	4.1	0.0085	2.5	0.0055
MCF 54	190		50	80	120	62	100	90	50	21	155	115	75	4.4	0.009	2.8	0.0064
MCF 55	230		65	105	163	108	143	72	72	23	159	117	75	9.9	0.032	5.7	0.021
MCF 56	238		70	112	172	114	150	60	80	31	175	125	75	11.8	0.043	6.8	0.028
MCF 58	290		75	120	224	168	203	45	90	41	195	135	75	17.8	0.101	10.1	0.065
MCF 510	320		80	130	254	200	234	36	100	53	219	147	75	24.2	0.17	13.6	0.108
MCF 65	390		90	144	270	164	240	72	110	38	246	181	116	35.5	0.31	21.5	0.21
MCF 66	462		100	160	352	249	322	60	122	50	270	193	116	53.8	0.76	31.4	0.50
MCF 68	540		60	120	192	420	319	390	45	145	72	316	216	116	85.6	1.63	48.8
MCF 69	558	60	120	192	442	340	410	40	165	85	356	236	116	97.3	2.01	55.4	1.30
MCF 610	638	75	140	224	520	422	490	36	165	93	356	236	116	130	3.67	72.7	2.32
MCF 75	675	85	155	248	454	280	404	72	180	55	386	293	200	170	4.28	107	3.11
MCF 76	750	100	175	280	530	358	480	60	195	70	416	308	200	228	7.58	141	5.45
MCF 78	892	110	190	304	675	507	625	45	222	97	470	335	200	332	17.42	202	12.42
MCF 710	1040	120	215	344	825	660	775	36	245	120	516	358	200	479	35.83	285	24.97

<sup>1)</sup> Values for maximum bore

# MULTI CROSS FORTE

## Mounting for Rubber Elements

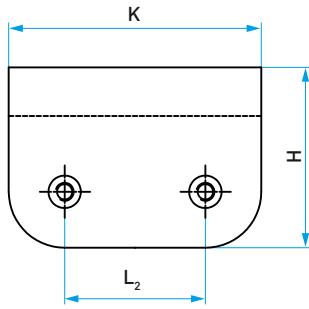

Element

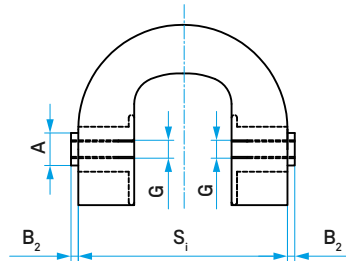

Type GG

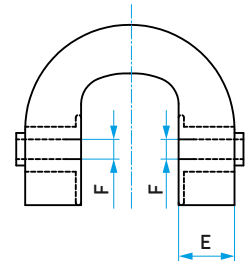

Type DD

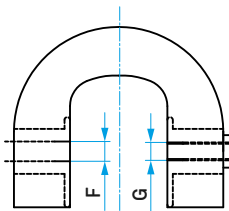

Type GD

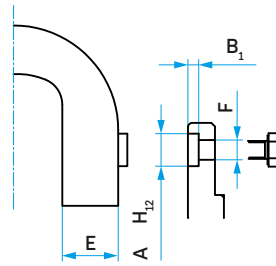

Detail: Design G

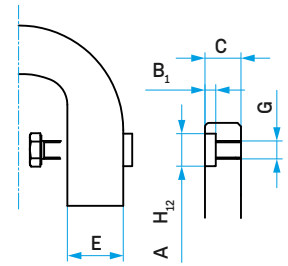

Detail: Design D

### Connection dimensions

Type series	A	B <sub>1</sub>	B <sub>2</sub>	C min.	E	F	G	H	K	L <sub>2</sub>	M <sub>A</sub> [Nm]	Connection bolt for C min.	
												Design G	Design D
5	11	5 + 0.5	3	17	18	6.6	M6	56	69	39 ± 0.2	10	M6 x 30	M6 x 30 DIN 933
6	18	6 + 0.5	4	24	31	11.0	M10	97	140	78 ± 0.2	49	M10 x 35	M10 x 55 DIN 933
7	33	7 + 0.5	5	33	57	22.0	M20	173	230	126 ± 0.2	410	M20 x 60	M20 x 90 DIN 933

Depending on the type of element mounting or coupling design, the following element have to be distinguished:

- Type GG with thread to connect bolts from the outside (for shaft couplings)
- Type GD with clearance hole and thread one side (for flange couplings)
- Type DD with clearance hole to bolt from inside (for double flange couplings)







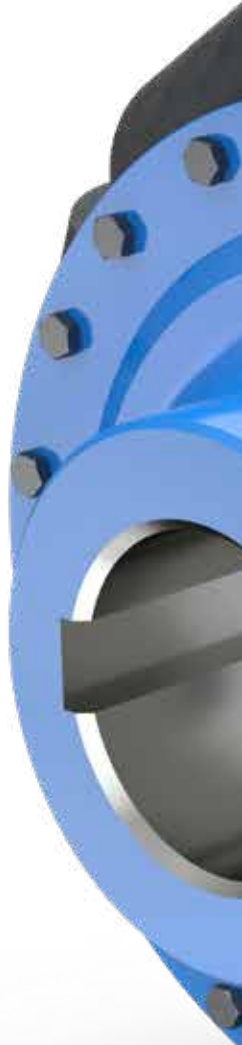

## MULTI CROSS FORTE

SIMPLY **POWERFUL.** 





### Industrial solutions:

-  Power generation
-  Mobile applications
-  Test benches
-  Pumps & compressors
-  Industry
-  Ship & port engineering

### Headquarter:

Dipl.-Ing. Herwarth Reich GmbH  
Vierhausstrasse 53 · 44807 Bochum

-  +49 234 95916-0
-  [mail@reich-kupplungen.com](mailto:mail@reich-kupplungen.com)
-  [www.reich-kupplungen.com](http://www.reich-kupplungen.com)

### Copyright ISO 16016 to be observed:

The reproduction, distribution and utilisation of this document as well as the communication of its contents to others without explicit authorisation is prohibited. Offenders will be held liable for the payment of damages. All rights reserved in the event of the grant of a patent, utility model or design. © REICH - Dipl.- Ing. Herwarth Reich GmbH

### March 2020 edition

The present MULTI CROSS FORTE catalogue edition renders parts of the previous MULTI CROSS FORTE catalogues obsolete. All dimensions in millimetres. We reserve the right to change dimensions and/or design without prior notice. Texts and illustrations, dimensional and performance data have been compiled with the utmost care. There is no guarantee, however, that the information is accurate; in particular, there is no guarantee that products will match the illustrations in terms of technology, colour, shape and configuration or that the products will correspond to the proportions of the illustrations. We also reserve the right to make changes due to printing errors or mistakes.